

**Features**

- Surface Mount Devices
- Lead free device
- Size 4.5*3.2 mm/0.18*0.12 inch
- Surface Mount packaging for automated assembly

Applications

- Almost anywhere there is a low voltage power supply, up to 60V and a load to be protected, including:
- Computer mother board, Modem, USB hub
 - PDAs & Charger, Analog & digital line card
 - Digital cameras, Disk drivers, CD-ROMs,

mSMD Series

Alpha-Top (Sea&Land Alliance)

Performance Specification

Model	V _{max} (Vdc)	I _{max} (A)	I _{hold} @25°C (A)	I _{trip} @25°C (A)	P _d Typ. (W)	Maximum Time To Trip		Resistance		Agency Approval	
						Current (A)	Time (Sec)	R _{i_min} (Ω)	R _{1_max} (Ω)	UL	TUV
mSMD010	30	100	0.10	0.30	0.8	0.5	1.50	0.750	15.000	✓	
mSMD010-60V	60	100	0.10	0.30	0.8	0.5	1.50	0.750	15.000		
mSMD014	60	100	0.14	0.34	0.8	1.5	0.15	0.650	6.000		
mSMD020	30	100	0.20	0.40	0.8	8.0	0.02	0.350	5.000		
mSMD020-60V	60	100	0.20	0.40	0.8	8.0	0.02	0.350	5.000		
mSMD030	30	100	0.30	0.60	0.8	8.0	0.10	0.250	3.000		
mSMD030-60V	60	100	0.30	0.60	0.8	8.0	0.10	0.250	3.000		
mSMD050	15	100	0.50	1.00	0.8	8.0	0.15	0.150	1.000	✓	
mSMD050-33V	33	100	0.50	1.00	0.8	8.0	0.15	0.150	1.000	✓	
mSMD050-60V	60	100	0.50	1.00	0.8	8.0	0.15	0.150	1.000		
mSMD075	13.2	100	0.75	1.50	0.8	8.0	0.20	0.090	0.450	✓	
mSMD075-16V	16	100	0.75	1.50	0.8	8.0	0.20	0.090	0.450		
mSMD075-24V	24	100	0.75	1.50	0.8	8.0	0.20	0.090	0.450		
mSMD075-33V	33	100	0.75	1.50	0.8	8.0	0.20	0.090	0.450		
mSMD100	8	100	1.00	1.80	0.8	8.0	0.30	0.055	0.270		
mSMD100-16V	16	100	1.00	1.80	0.8	8.0	0.30	0.055	0.270		
mSMD100-24V	24	100	1.00	1.80	0.8	8.0	0.30	0.055	0.270		
mSMD100-33V	33	100	1.00	1.80	0.8	8.0	0.30	0.055	0.270		
mSMD110	8	100	1.10	2.20	0.8	8.0	0.30	0.050	0.250	✓	
mSMD110-16V	16	100	1.10	2.20	0.8	8.0	0.30	0.050	0.250		
mSMD110-24V	24	100	1.10	2.20	0.8	8.0	0.30	0.050	0.250		
mSMD110-33V	33	100	1.10	2.20	0.8	8.0	0.30	0.050	0.250		
mSMD125	16	100	1.25	2.50	0.8	8.0	0.40	0.050	0.140		
mSMD150	8	100	1.50	3.00	0.8	8.0	0.50	0.040	0.160	✓	
mSMD150-16V	16	100	1.50	3.00	0.8	8.0	0.50	0.040	0.160		
mSMD150-24V	24	100	1.50	3.00	0.8	8.0	0.50	0.040	0.160		
mSMD160	8	100	1.60	2.80	0.8	8.0	1.00	0.030	0.130	✓	
mSMD160-13.2V	13.2	100	1.60	2.80	0.8	8.0	1.00	0.030	0.130		
mSMD160-16V	16	100	1.60	2.80	0.8	8.0	1.00	0.030	0.130		
mSMD200	8	100	2.00	4.00	0.8	8.0	2.00	0.020	0.100	✓	
mSMD200-13.2V	13.2	100	2.00	4.00	0.8	8.0	2.00	0.020	0.100		
mSMD200-16V	16	100	2.00	4.00	0.8	8.0	2.00	0.020	0.100		
mSMD260	8	100	2.60	5.00	0.8	8.0	2.50	0.015	0.050	✓	✓
mSMD260-13.2V	13.2	100	2.60	5.00	0.8	8.0	2.50	0.015	0.050		
mSMD300	8	100	3.00	5.00	0.8	8.0	4.00	0.012	0.040		
mSMD300-13.2V	13.2	100	3.00	5.00	0.8	8.0	4.00	0.012	0.040		
mSMD350	6	100	3.50	6.00	2.0	10.0	4.00	0.008	0.030		
mSMD375	6	100	3.75	7.00	2.0	12.0	4.00	0.007	0.028		
mSMD400	6	100	4.00	8.00	2.0	12.0	5.00	0.006	0.025		

I_{hold} = Hold Current. Maximum current device will not trip in 25°C still air.**I_{trip}** = Trip Current. Minimum current at which the device will always trip in 25°C still air.**V_{max}** = Maximum operating voltage device can withstand without damage at rated current (I_{max}).**I_{max}** = Maximum fault current device can withstand without damage at rated voltage (V_{max}).**P_d** = Power dissipation when device is in the tripped state in 25°C still air environment at rated voltage.**R_{imin/max}** = Minimum/Maximum device resistance prior to tripping at 25°C.**R_{1_max}** = Maximum device resistance is measured one hour post reflow.**CAUTION** : Operation beyond the specified ratings may result in damage and possible arcing and flame.

mSMD Series

Alpha-Top (Sea&Land Alliance)

Environmental Specifications

Test	Conditions
Passive aging	+85°C, 1000 hrs.
Humidity aging	+85°C, 85% R.H. , 168 hours
Thermal shock	+85°C to -40°C, 20 times
Resistance to solvent	MIL-STD-202,Method 215
Vibration	MIL-STD-202,Method 201
Ambient operating conditions : - 40 °C to +85 °C	
Maximum surface temperature of the device in the tripped state is 125 °C	

Agency Approvals :



E201504(Alpha-Top)/E319079(Sea&Land)



R 50265895

Regulation/Standard:



2002/95/EC
EN14582

I_{hold} Versus Temperature

Model	Maximum ambient operating temperature (T _{mao}) vs. hold current (I _{hold})								
	-40°C	-20°C	0°C	25°C	40°C	50°C	60°C	70°C	85°C
mSMD010	0.16	0.14	0.12	0.10	0.08	0.07	0.06	0.05	0.03
mSMD014	0.23	0.19	0.17	0.14	0.12	0.10	0.09	0.08	0.06
mSMD020	0.29	0.26	0.23	0.20	0.17	0.15	0.14	0.12	0.10
mSMD030	0.44	0.39	0.35	0.30	0.26	0.23	0.21	0.18	0.15
mSMD050	0.59	0.57	0.55	0.50	0.45	0.43	0.35	0.30	0.23
mSMD075	1.10	0.99	0.87	0.75	0.63	0.57	0.49	0.45	0.35
mSMD100	1.45	1.32	1.16	1.00	0.84	0.75	0.68	0.60	0.48
mSMD110	1.60	1.45	1.28	1.10	0.92	0.83	0.71	0.66	0.52
mSMD125	2.00	1.75	1.52	1.25	1.00	0.95	0.90	0.75	0.53
mSMD150	2.30	2.05	1.77	1.50	1.23	1.09	0.95	0.82	0.61
mSMD160	2.10	1.96	1.88	1.60	1.26	1.12	0.98	0.84	0.63
mSMD200	2.88	2.61	2.25	2.00	1.80	1.66	1.45	1.09	0.80
mSMD260	3.90	3.42	2.96	2.60	2.33	2.07	1.94	1.35	1.00
mSMD300	4.15	3.76	3.46	3.00	2.55	2.28	2.01	1.61	1.33
mSMD350	4.84	4.39	4.04	3.50	2.98	2.66	2.35	1.88	1.55
mSMD375	5.45	4.94	4.36	3.75	3.14	2.83	2.54	2.25	1.82
mSMD400	5.81	5.27	4.65	4.00	3.35	3.02	2.71	2.40	1.94

α
375 α
300 α
110 α
030 α
010**mSMD Series**

Alpha-Top (Sea&Land Alliance)

Construction And Dimension (Unit:mm)

Model	A		B		C		D	E
	Min.	Max.	Min.	Max.	Min.	Max.	Min.	Min.
mSMD010	4.37	4.73	3.07	3.41	0.50	1.00	0.30	0.25
mSMD010-60V	4.37	4.73	3.07	3.41	0.50	1.00	0.30	0.25
mSMD014	4.37	4.73	3.07	3.41	0.50	1.00	0.30	0.25
mSMD020	4.37	4.73	3.07	3.41	0.50	1.30	0.30	0.25
mSMD020-60V	4.37	4.73	3.07	3.41	0.50	1.30	0.30	0.25
mSMD030	4.37	4.73	3.07	3.41	0.50	1.00	0.30	0.25
mSMD030-60V	4.37	4.73	3.07	3.41	0.50	1.00	0.30	0.25
mSMD050	4.37	4.73	3.07	3.41	0.40	0.90	0.30	0.25
mSMD050-33V	4.37	4.73	3.07	3.41	0.60	1.30	0.30	0.25
mSMD050-60V	4.37	4.73	3.07	3.41	1.10	1.80	0.30	0.25
mSMD075	4.37	4.73	3.07	3.41	0.40	0.90	0.30	0.25
mSMD075-16V	4.37	4.73	3.07	3.41	0.40	0.90	0.30	0.25
mSMD075-24V	4.37	4.73	3.07	3.41	0.60	1.30	0.30	0.25
mSMD075-33V	4.37	4.73	3.07	3.41	0.60	1.30	0.30	0.25
mSMD100	4.37	4.73	3.07	3.41	0.40	0.90	0.30	0.25
mSMD100-16V	4.37	4.73	3.07	3.41	0.60	1.30	0.30	0.25
mSMD100-24V	4.37	4.73	3.07	3.41	0.60	1.30	0.30	0.25
mSMD100-33V	4.37	4.73	3.07	3.41	1.10	1.80	0.30	0.25
mSMD110	4.37	4.73	3.07	3.41	0.40	0.90	0.30	0.25
mSMD110-16V	4.37	4.73	3.07	3.41	0.60	1.30	0.30	0.25
mSMD110-24V	4.37	4.73	3.07	3.41	0.60	1.30	0.30	0.25
mSMD110-33V	4.37	4.73	3.07	3.41	1.10	1.80	0.30	0.25
mSMD125	4.37	4.73	3.07	3.41	0.60	1.30	0.30	0.25
mSMD150	4.37	4.73	3.07	3.41	0.40	0.90	0.30	0.25
mSMD150-16V	4.37	4.73	3.07	3.41	0.60	1.30	0.30	0.25
mSMD150-24V	4.37	4.73	3.07	3.41	0.60	1.80	0.30	0.25
mSMD160	4.37	4.73	3.07	3.41	0.40	0.90	0.30	0.25
mSMD160-13.2V	4.37	4.73	3.07	3.41	0.60	1.30	0.30	0.25
mSMD160-16V	4.37	4.73	3.07	3.41	0.60	1.30	0.30	0.25
mSMD200	4.37	4.73	3.07	3.41	0.60	1.30	0.30	0.25
mSMD200-13.2V	4.37	4.73	3.07	3.41	0.60	1.30	0.30	0.25
mSMD200-16V	4.37	4.73	3.07	3.41	1.10	1.80	0.30	0.25
mSMD260	4.37	4.73	3.07	3.41	0.60	1.30	0.30	0.25
mSMD260-13.2V	4.37	4.73	3.07	3.41	0.60	1.30	0.30	0.25
mSMD300	4.37	4.73	3.07	3.41	0.50	1.30	0.30	0.25
mSMD300-13.2V	4.37	4.73	3.07	3.41	1.10	1.80	0.30	0.25
mSMD350	4.37	4.73	3.07	3.41	0.50	1.30	0.30	0.25
mSMD375	4.37	4.73	3.07	3.41	0.50	1.30	0.30	0.25
mSMD400	4.37	4.73	3.07	3.41	1.10	1.80	0.30	0.25

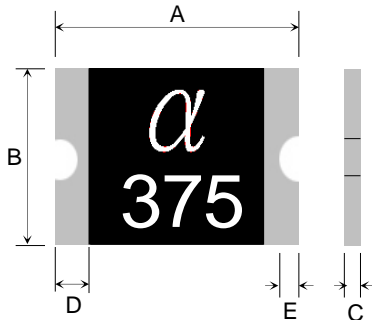
Dimensions & Marking

α = Trademark
375 = Hold current

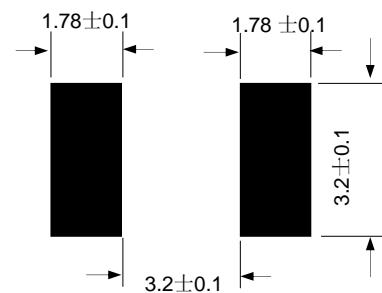
Recommended Pad Layout (mm)



mSMD Series

Alpha-Top (Sea&Land Alliance)

Termination Pad Characteristics

Terminal pad materials : Gold-Plated Nickel-Copper or Tin-plated Nickel-Copper

Terminal pad solderability : Meets EIA specification RS186-9E and ANSI/J-STD-002 Category 3.

Rework

Use standard industry practices, the removal device must be replaced with a fresh one.

Thermal Derating Curve

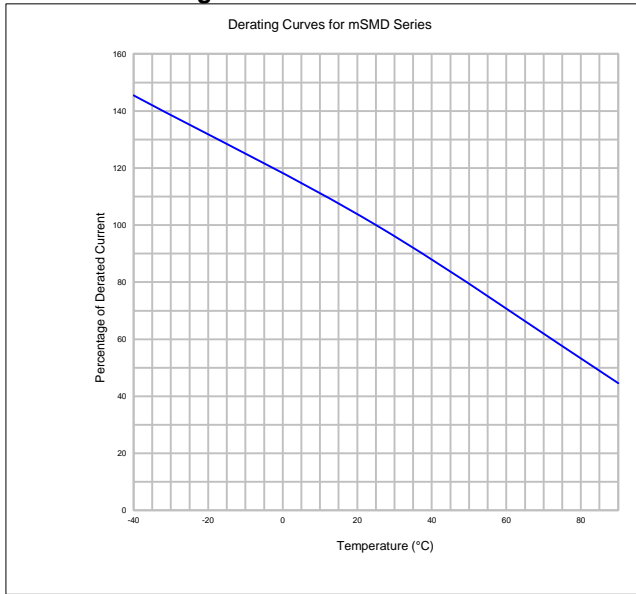

Typical Time-To-Trip At 25°C

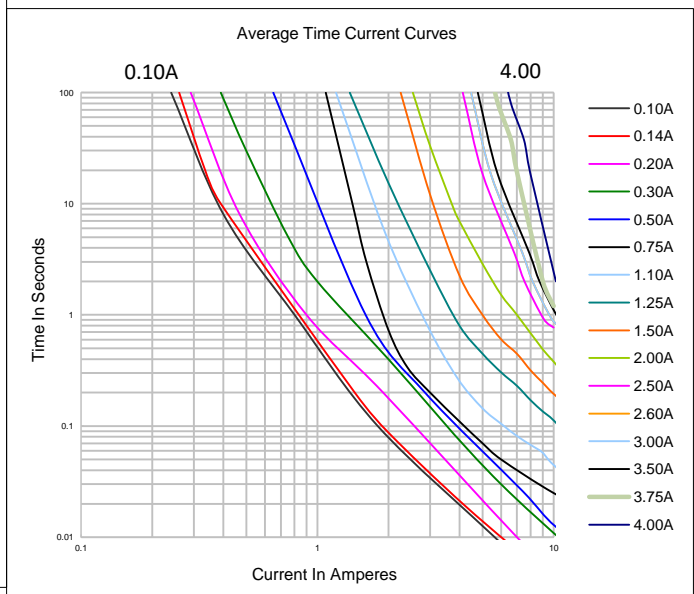

WARNING:

- Use PPTC beyond the maximum ratings or improper use may result in device damage and possible electrical arcing and flame.
- PPTC are intended for protection against occasional over current or over temperature fault conditions and should not be used when repeated fault conditions or prolonged trip events are anticipated.
- Device performance can be impacted negatively if devices are handled in a manner inconsistent with recommended electronic, thermal, and mechanical procedures for electronic components.
- Use PPTC with a large inductance in circuit will generate a circuit voltage ($L di/dt$) above the rated voltage of the PPTC.
- Avoid impact PPTC device its thermal expansion like placed under pressure or installed in limited space.
- Contamination of the PPTC material with certain silicon based oils or some aggressive solvents can adversely impact the performance of the devices. PPTC SMD can be cleaned by standard methods.
- Requests that customers comply with our recommended solder pad layouts and recommended reflow profile. Improper board layouts or reflow profile could negatively impact solderability performance of our devices.

Recommended Solder Reflow Conditions

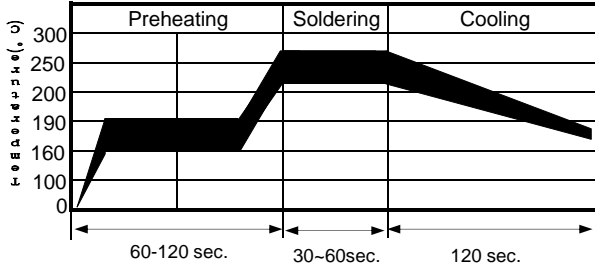

- Recommended reflow methods : IR, vapor phase oven, hot air oven.
 - Devices are not designed to be wave soldered to the bottom side of the board.
 - Recommended maximum paste thickness is 0.25 mm (0.010 inch).
 - Devices can be cleaned using standard method and solvents.
- Note : If reflow temperatures exceed the recommended profile, devices may not meet the performance requirements.

Tape And Reel Specifications (mm)

Governing Specifications EIA 481-1

W	12 ± 0.3
P0	4.0 ± 0.10
P1	8.0 ± 0.10
P2	2.0 ± 0.05
A0	3.5 ± 0.23
B0	5.1 ± 0.15
B1max.	5.9
D0	1.5 + 0.1, -0
F	5.5 ± 0.05
E1	1.75 ± 0.10
E2min.	10.25
Tmax.	0.6
T1max.	0.1
K0	0.9 ± 0.15
Leader min.	390
Trailer min.	160
Reel Dimensions	
A max.	178
N min.	60
W1	12.4 + 2.0, -0.0
W2max.	18.4

EIA Tape Component

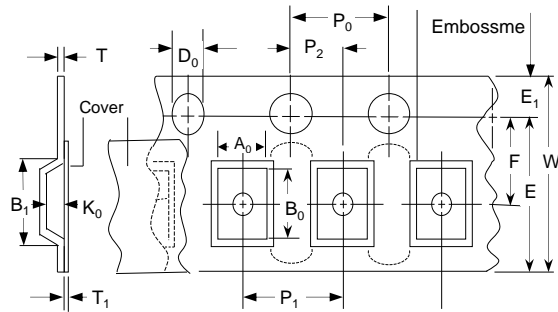

EIA Reel

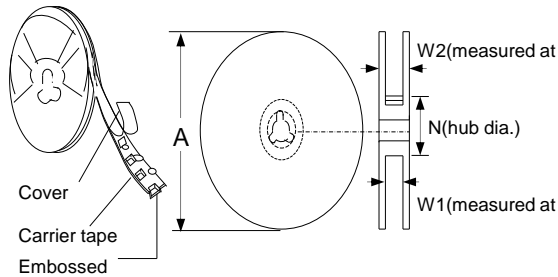

Storage And Handling

- Storage conditions : 40°C max, 70% R.H.
- Devices may not meet specified performance if storage conditions are exceeded.

Order Information

Packaging

mSMD	110	Tape & Reel Quantity
Product name	Hold	mSMD Series 1,500 pcs/reel
Size 4532 mm / 1812 inch	Current	
SMD : surface mount device	1.00A	

Devices taped with reference to EIA481 standard.